

Dimensiuni maxime

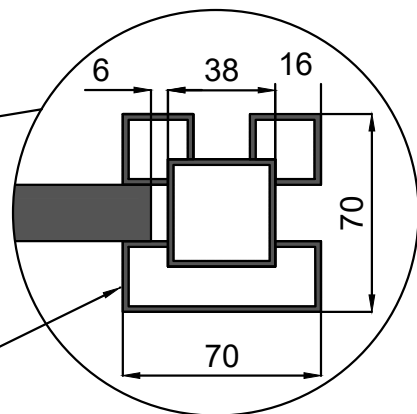

23-200/1.5
 23-200/2.0

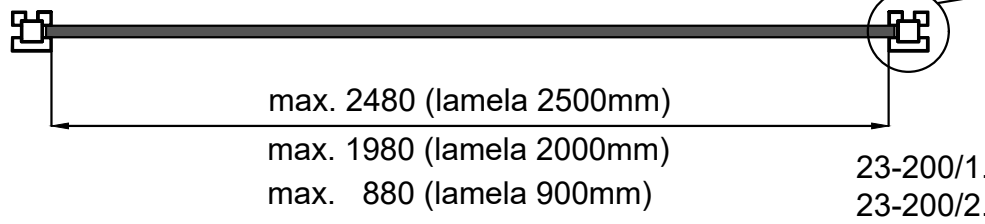
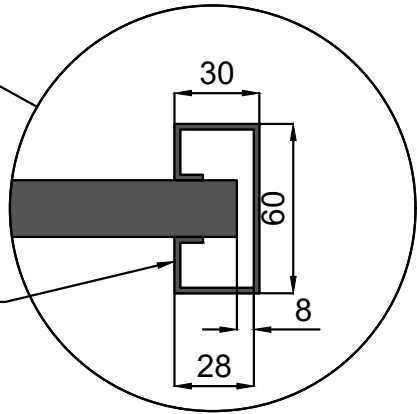
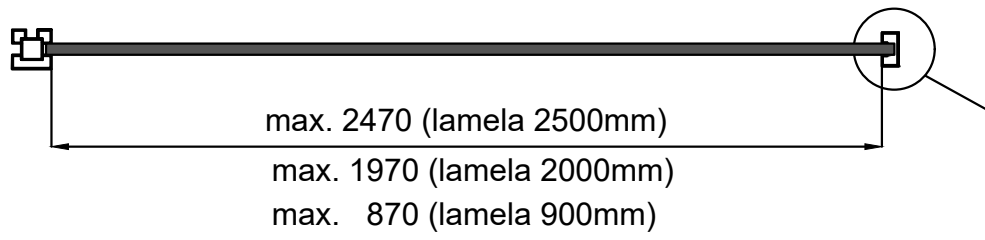

23-210/2.0

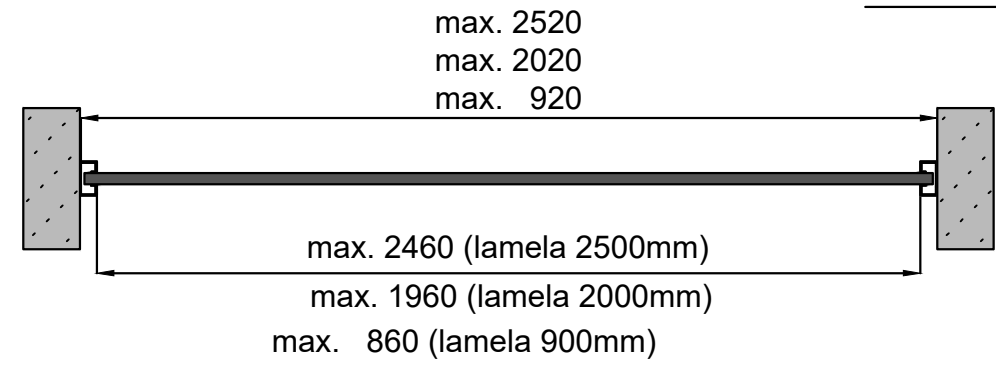

(max. 1978) stilp 2000 (23-200/2.0)

max. 1478 (stilp 1500) (23-200/1.5)

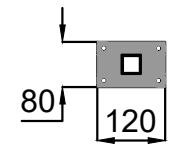
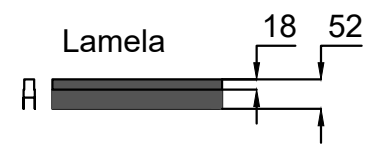
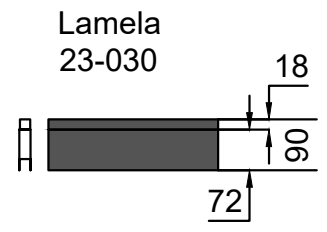
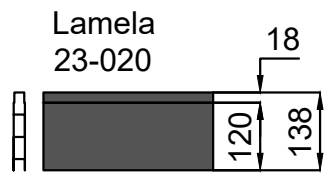
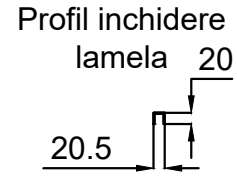
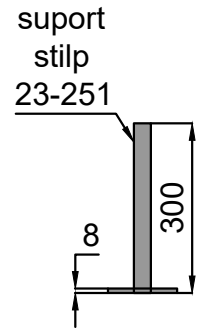
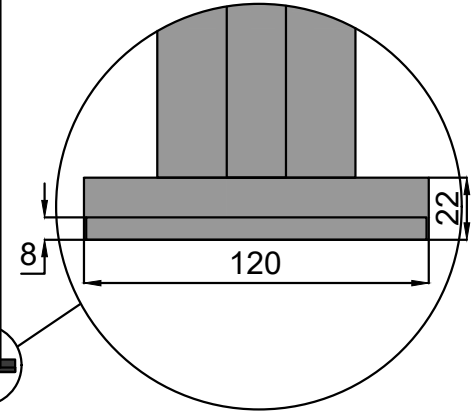
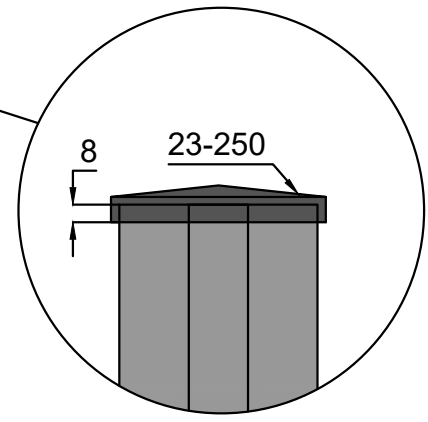

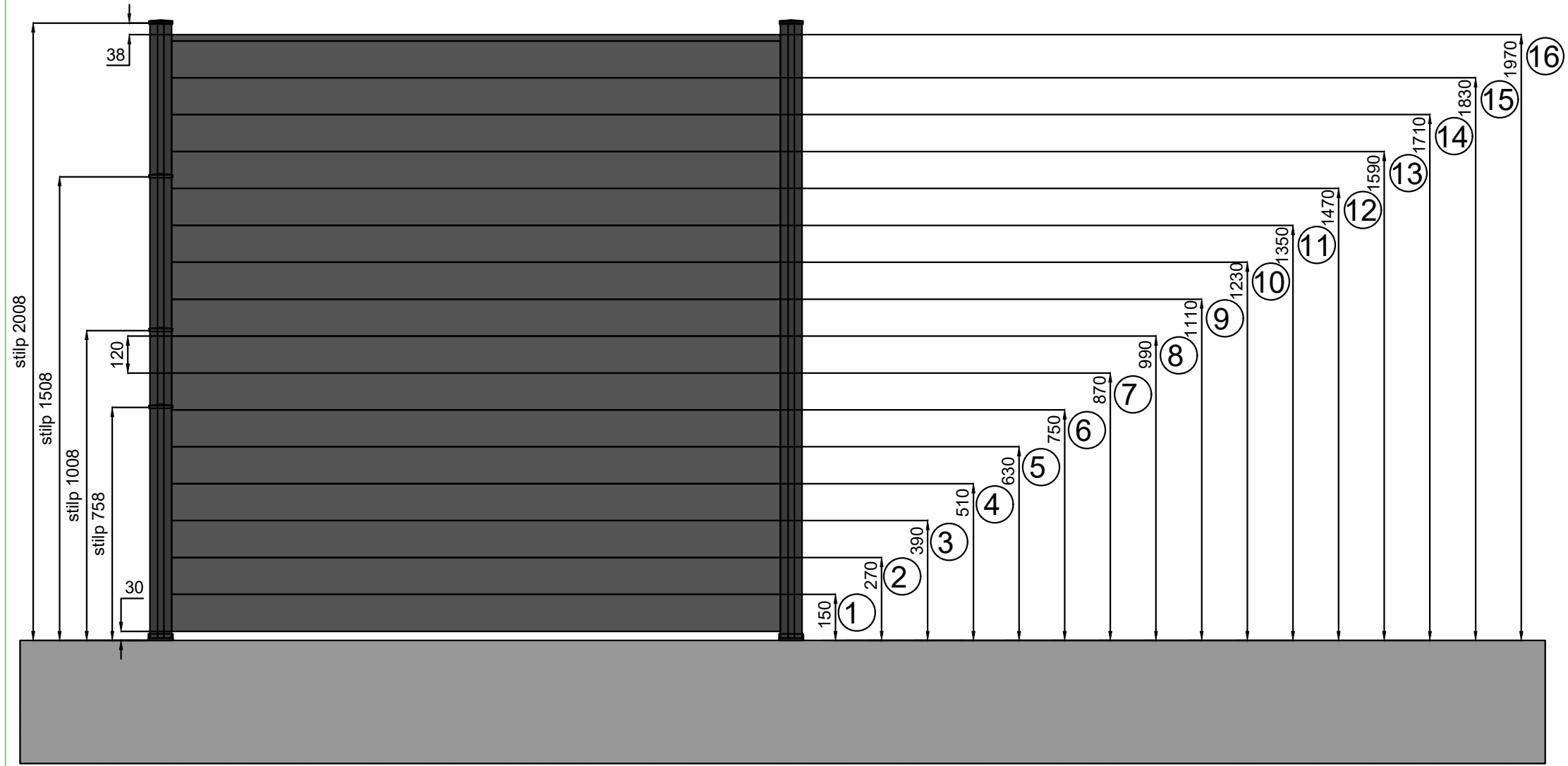

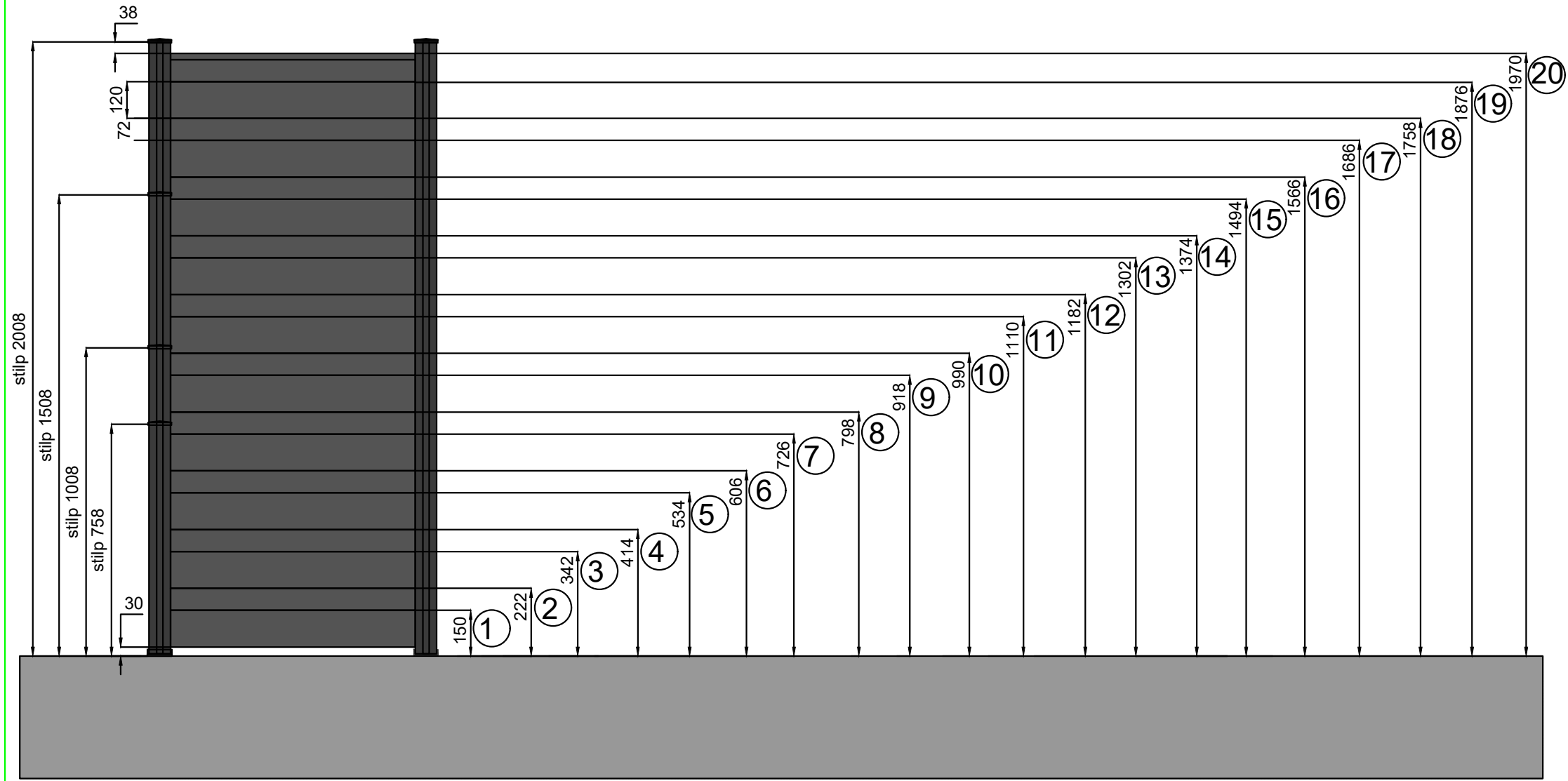

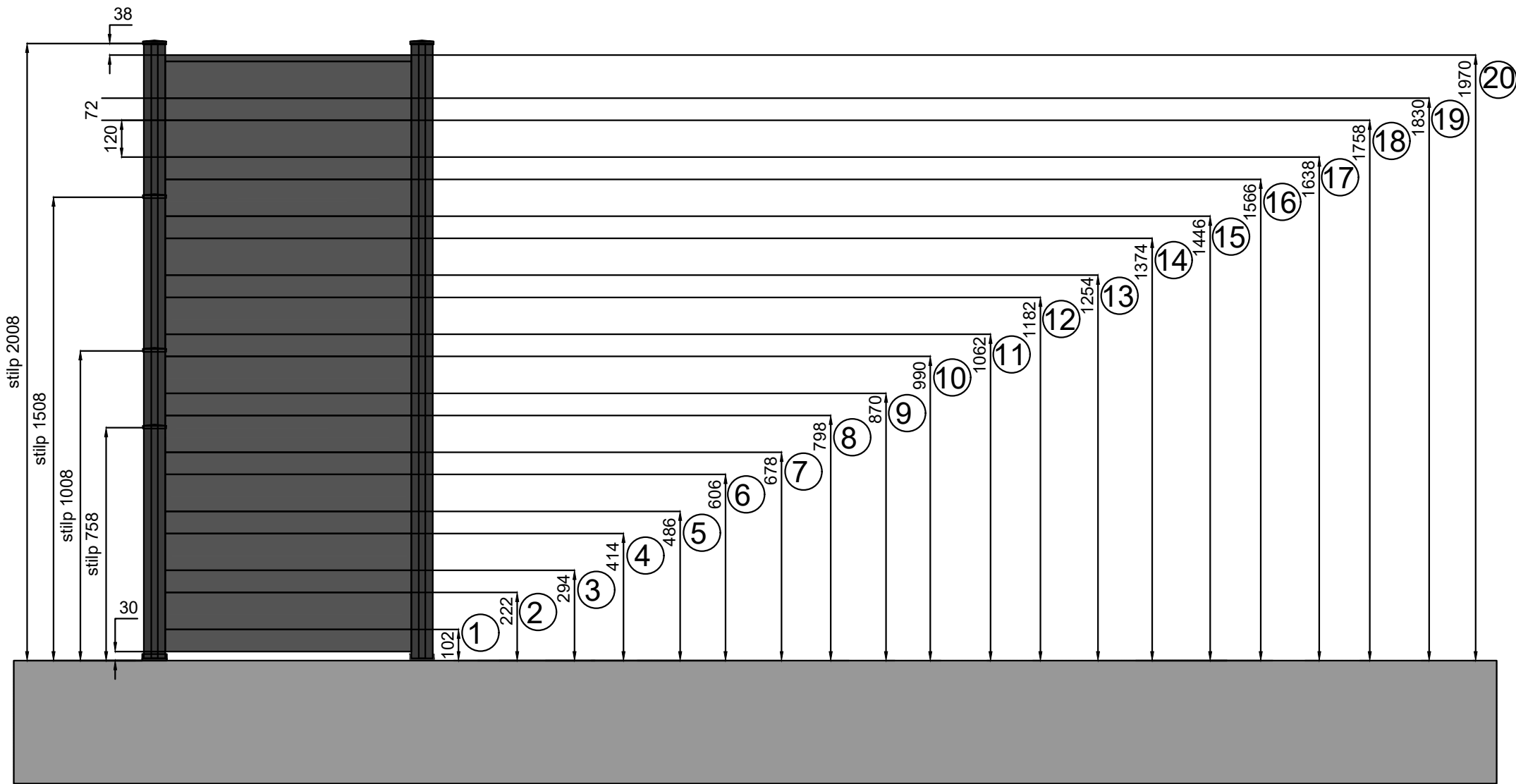

D-120/60

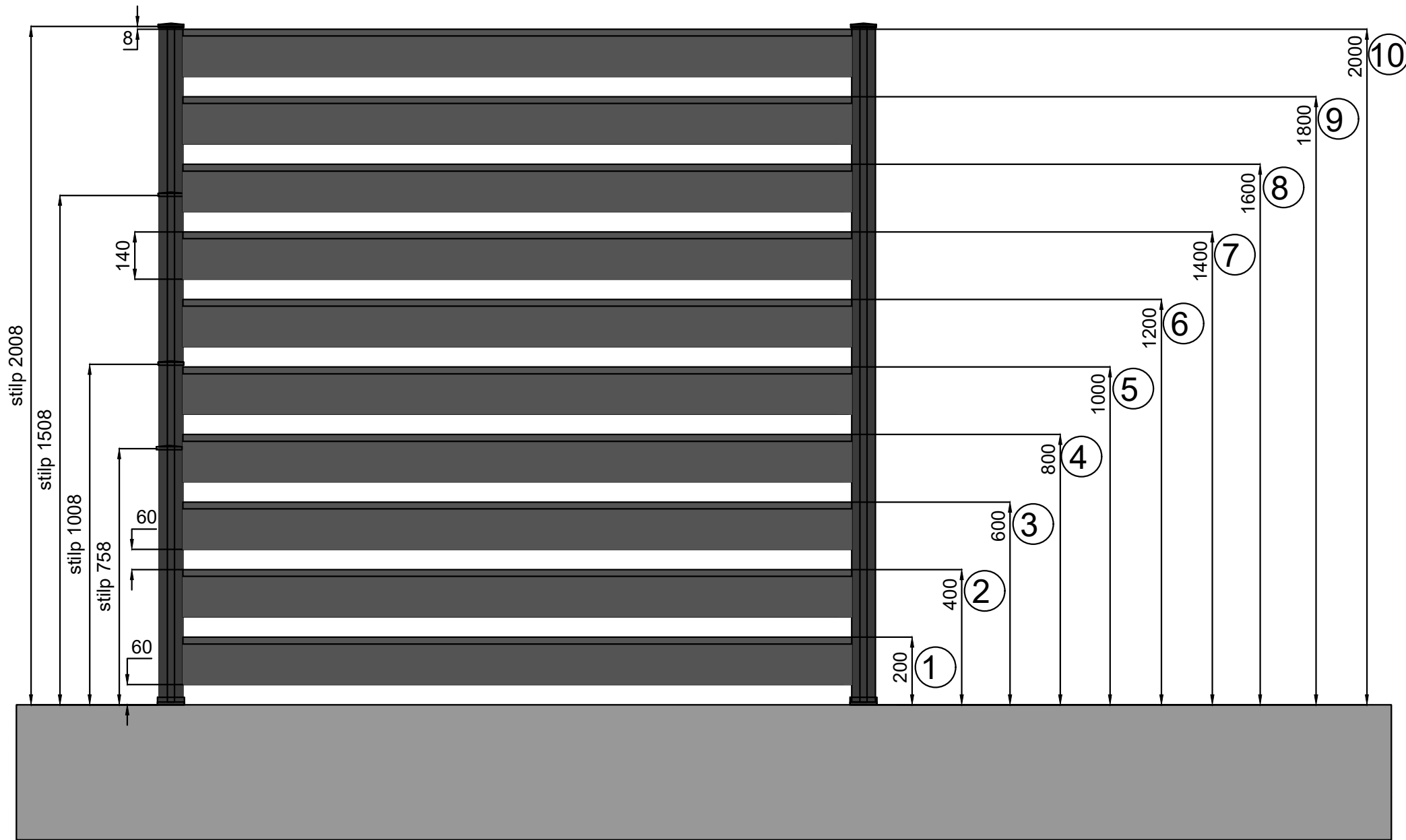

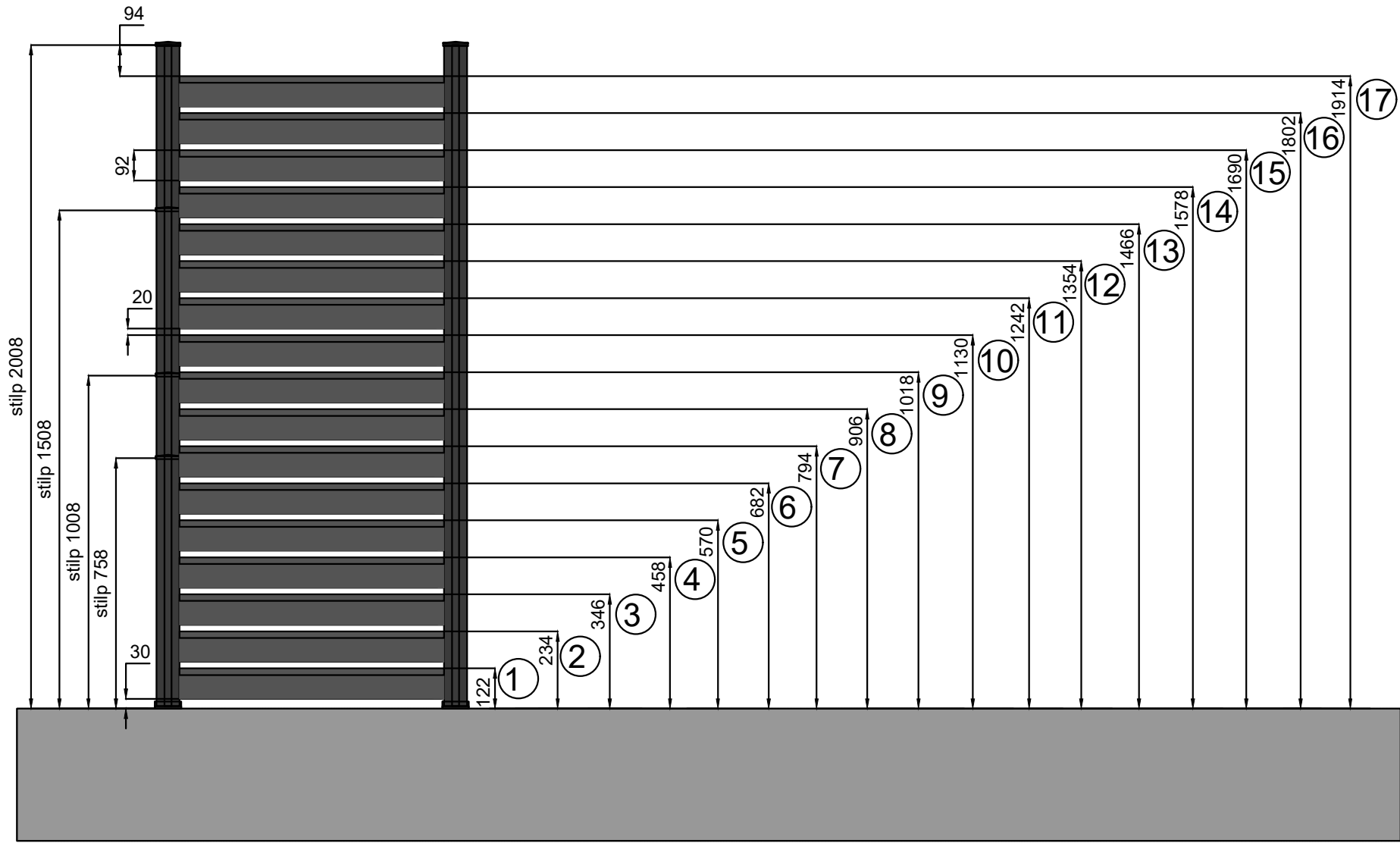

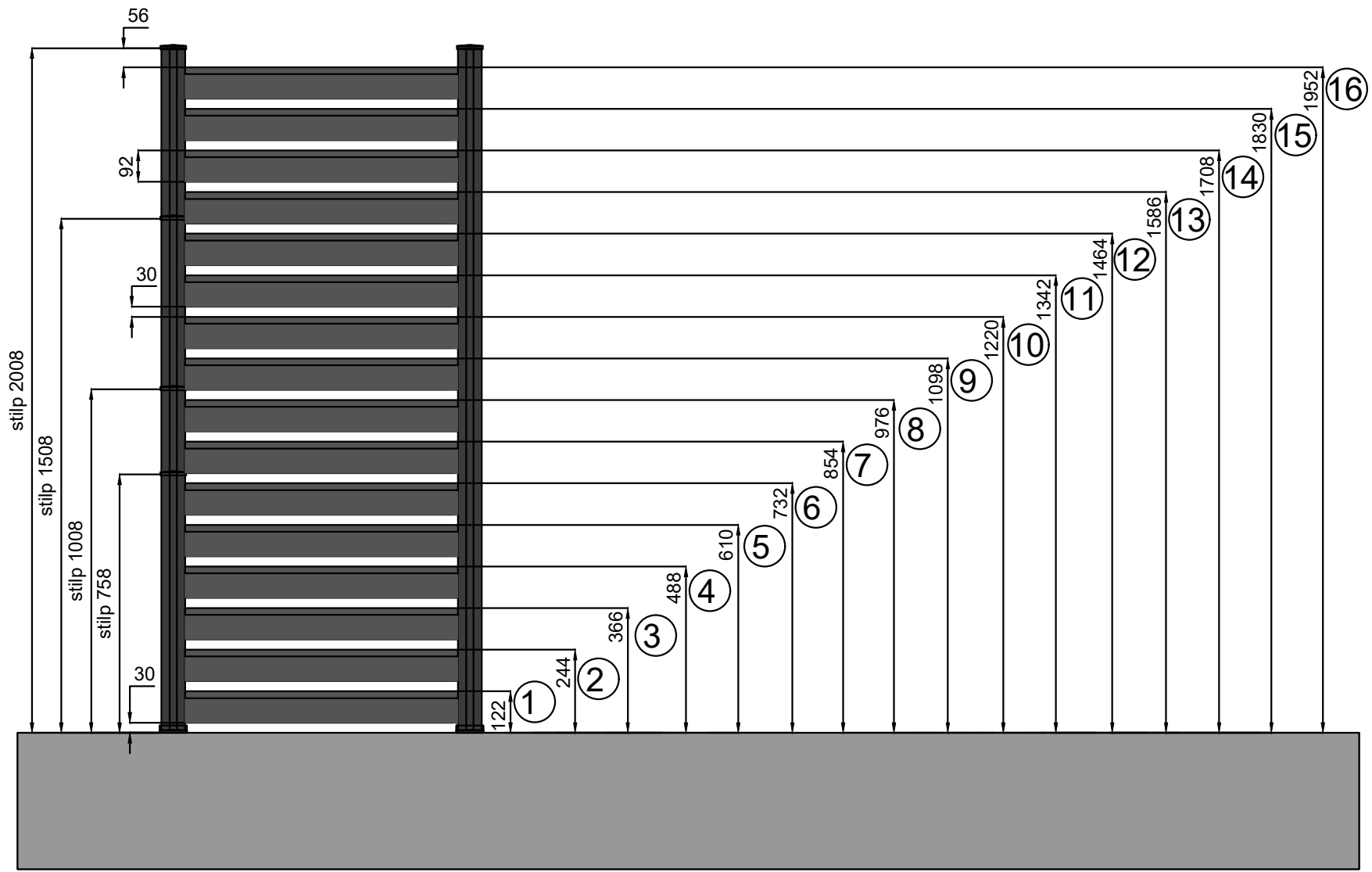

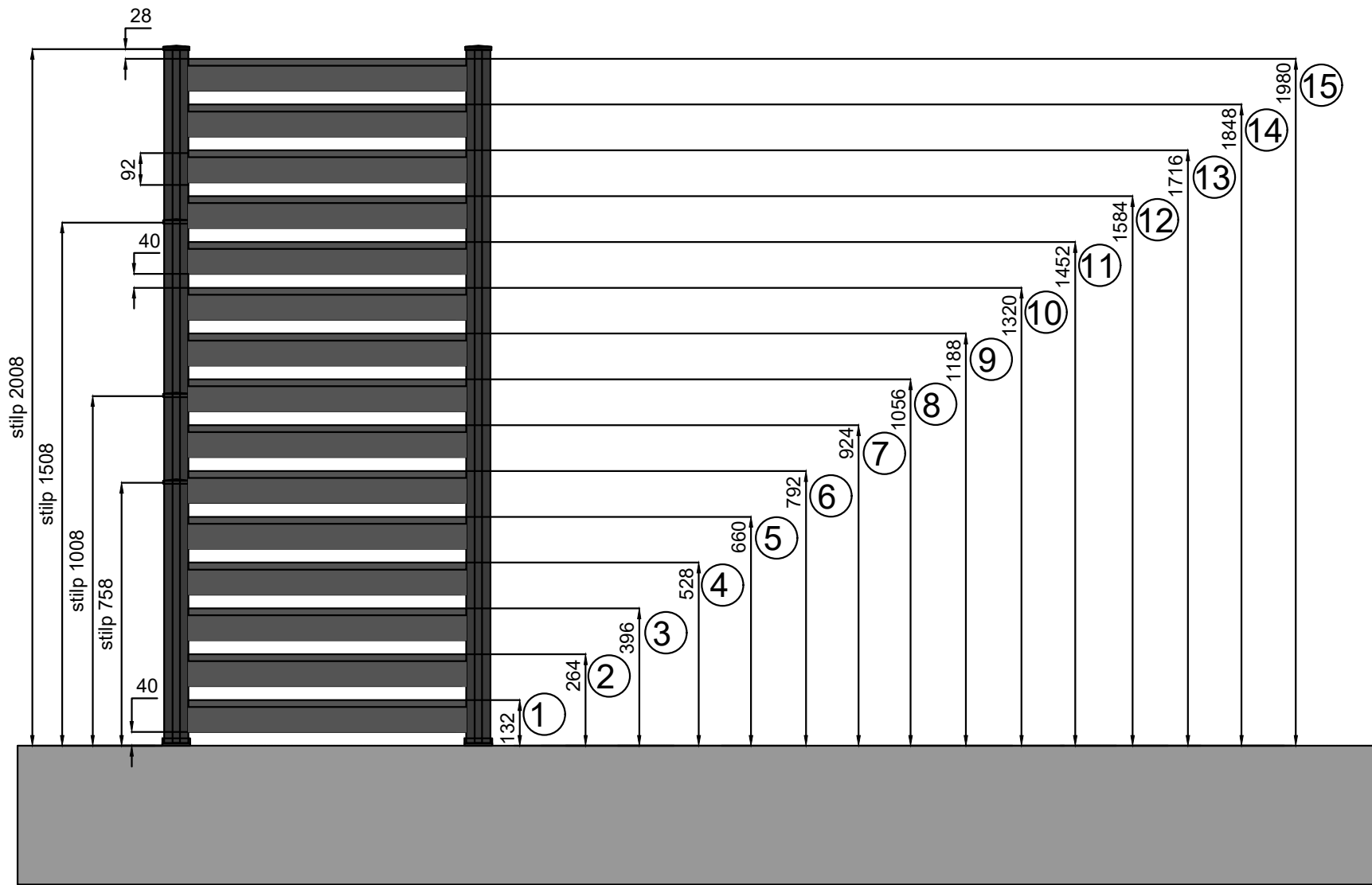

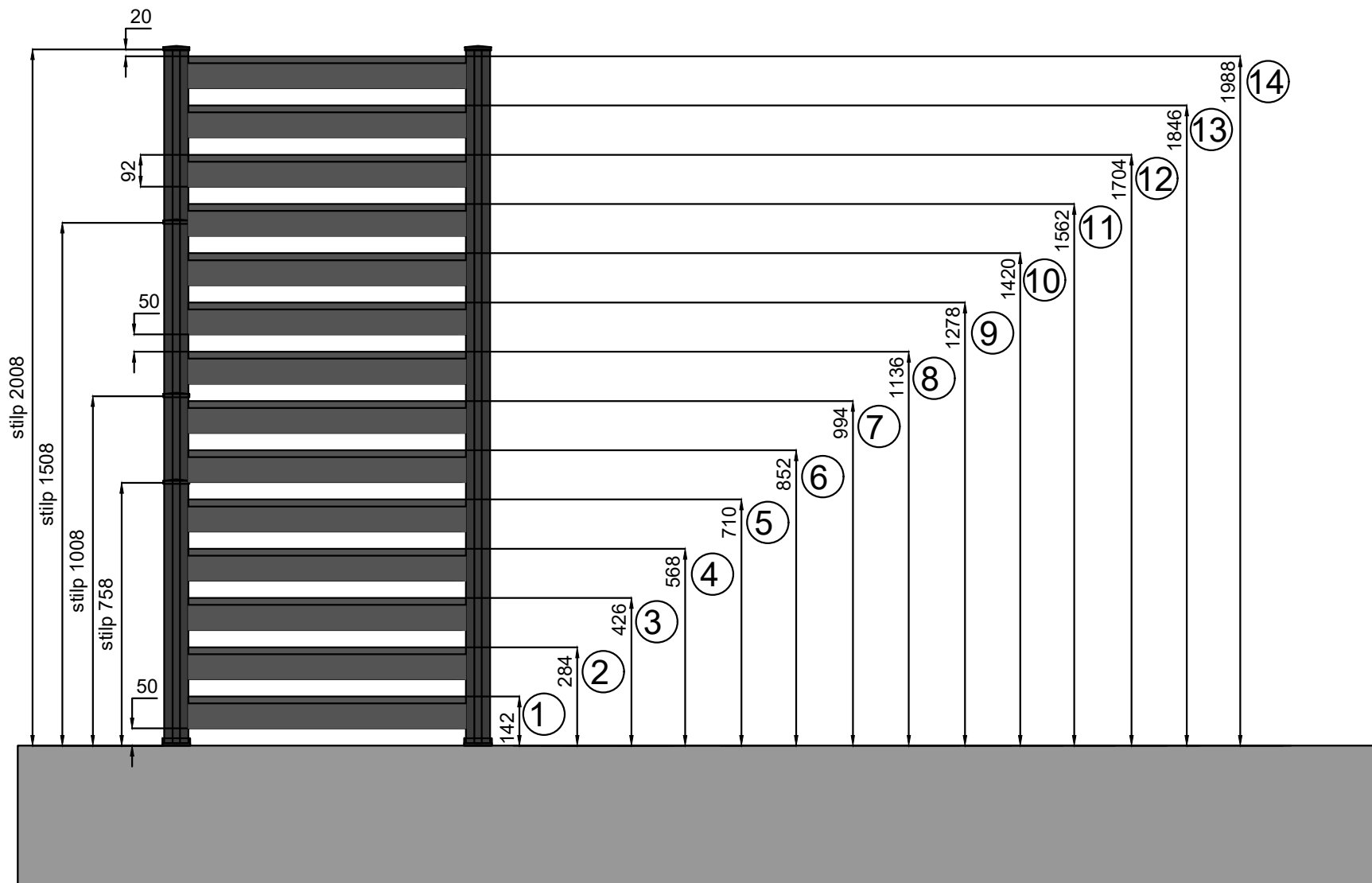

D-70/60

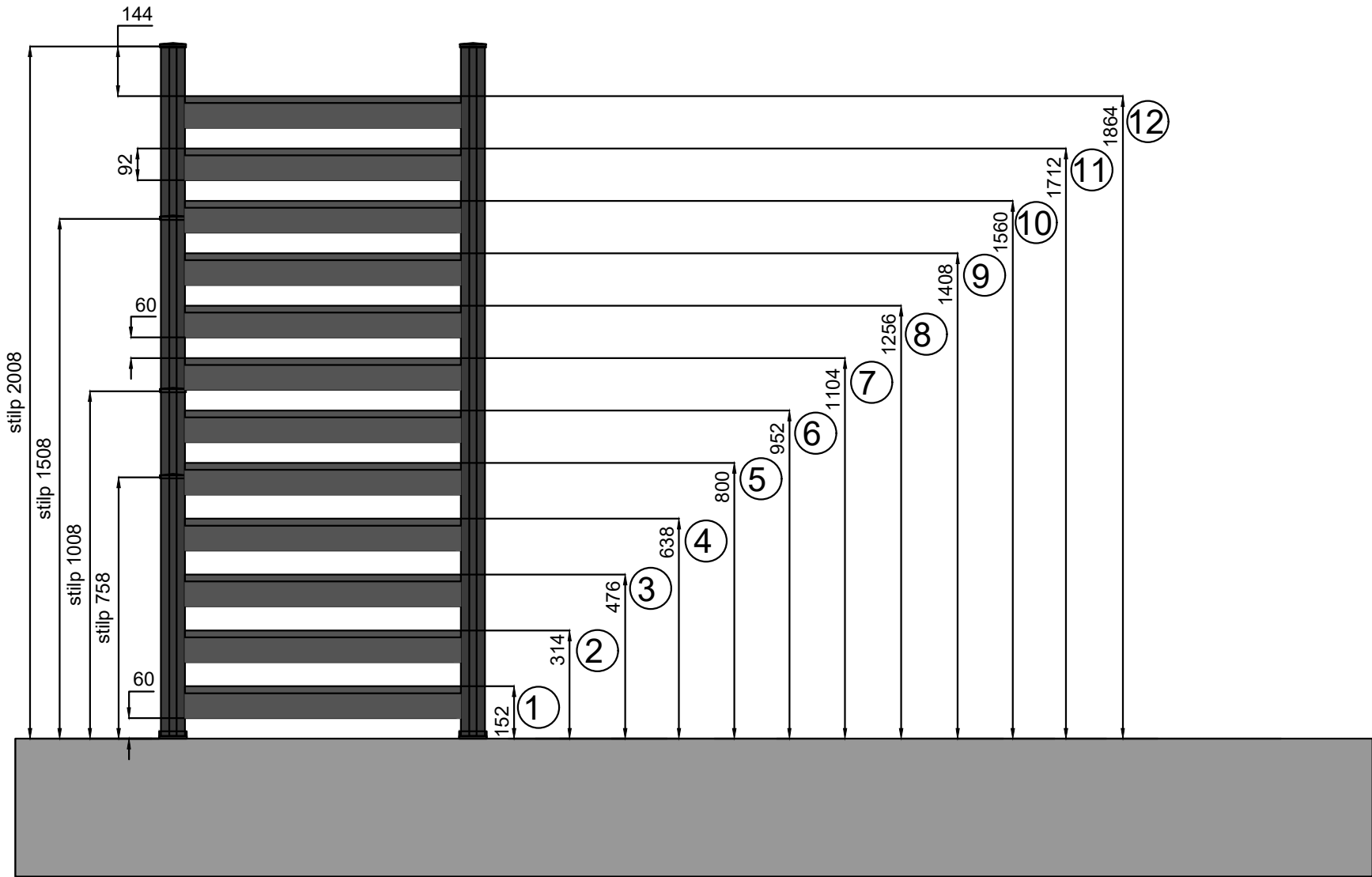

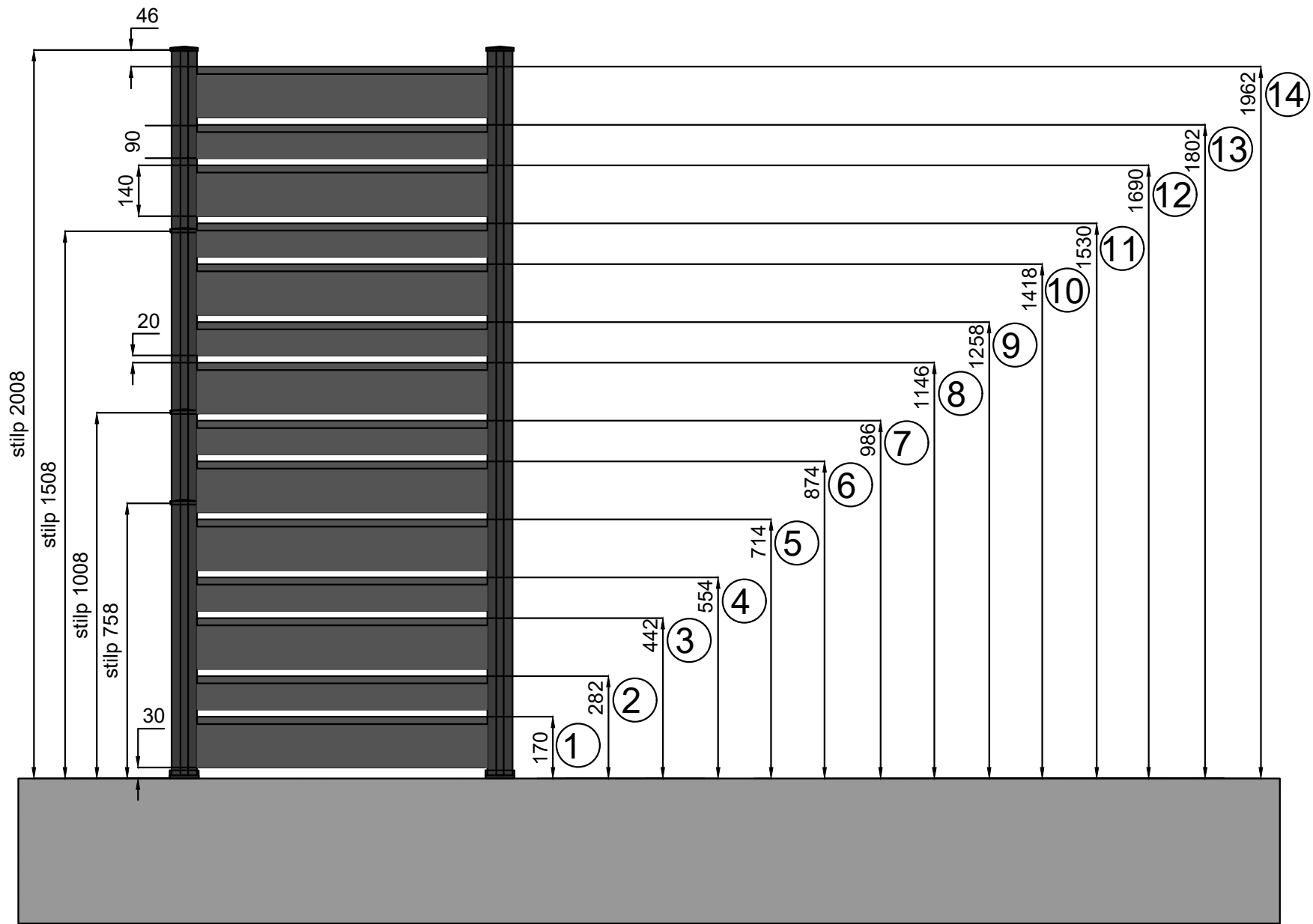

D-120/70/30

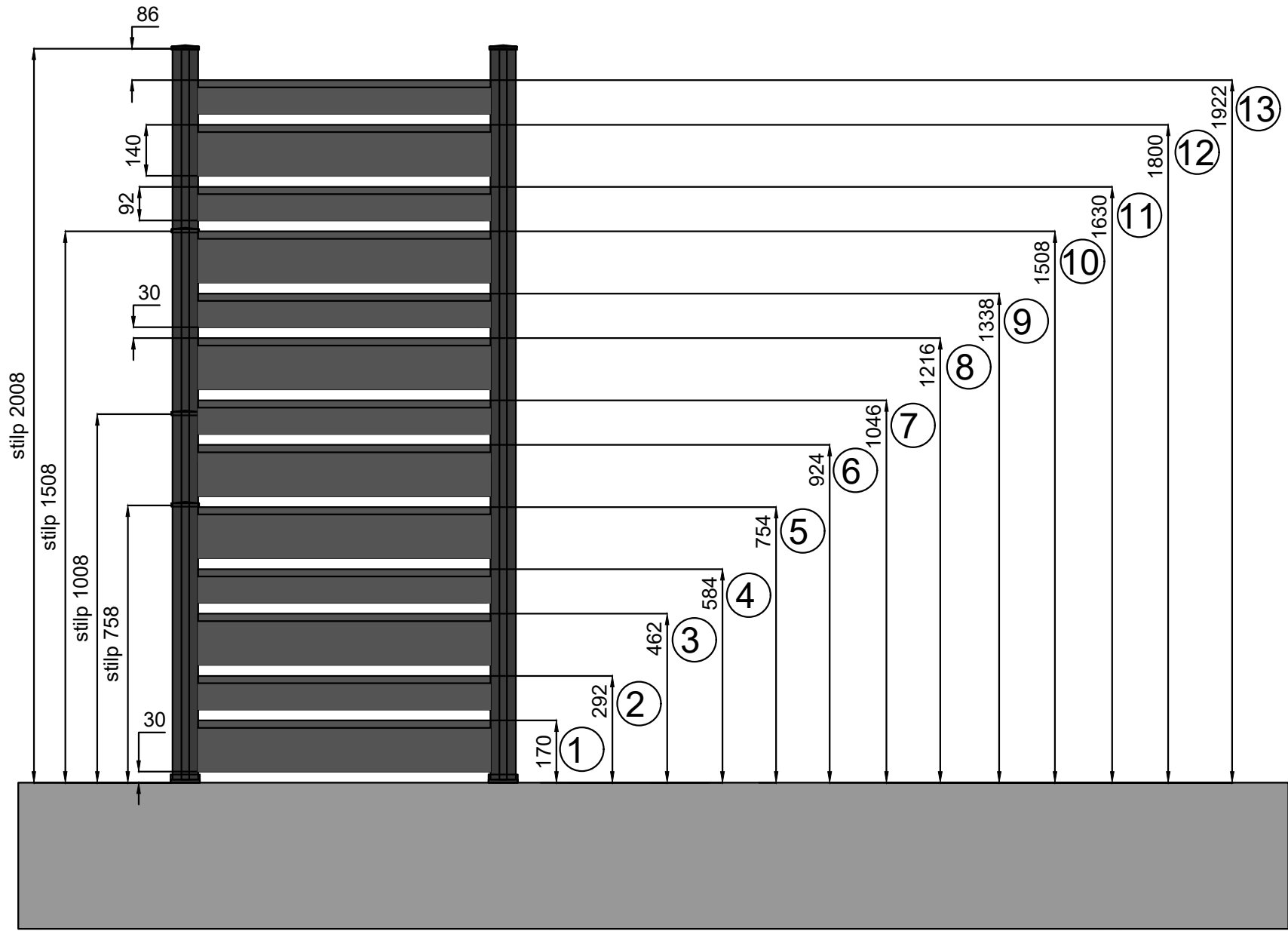

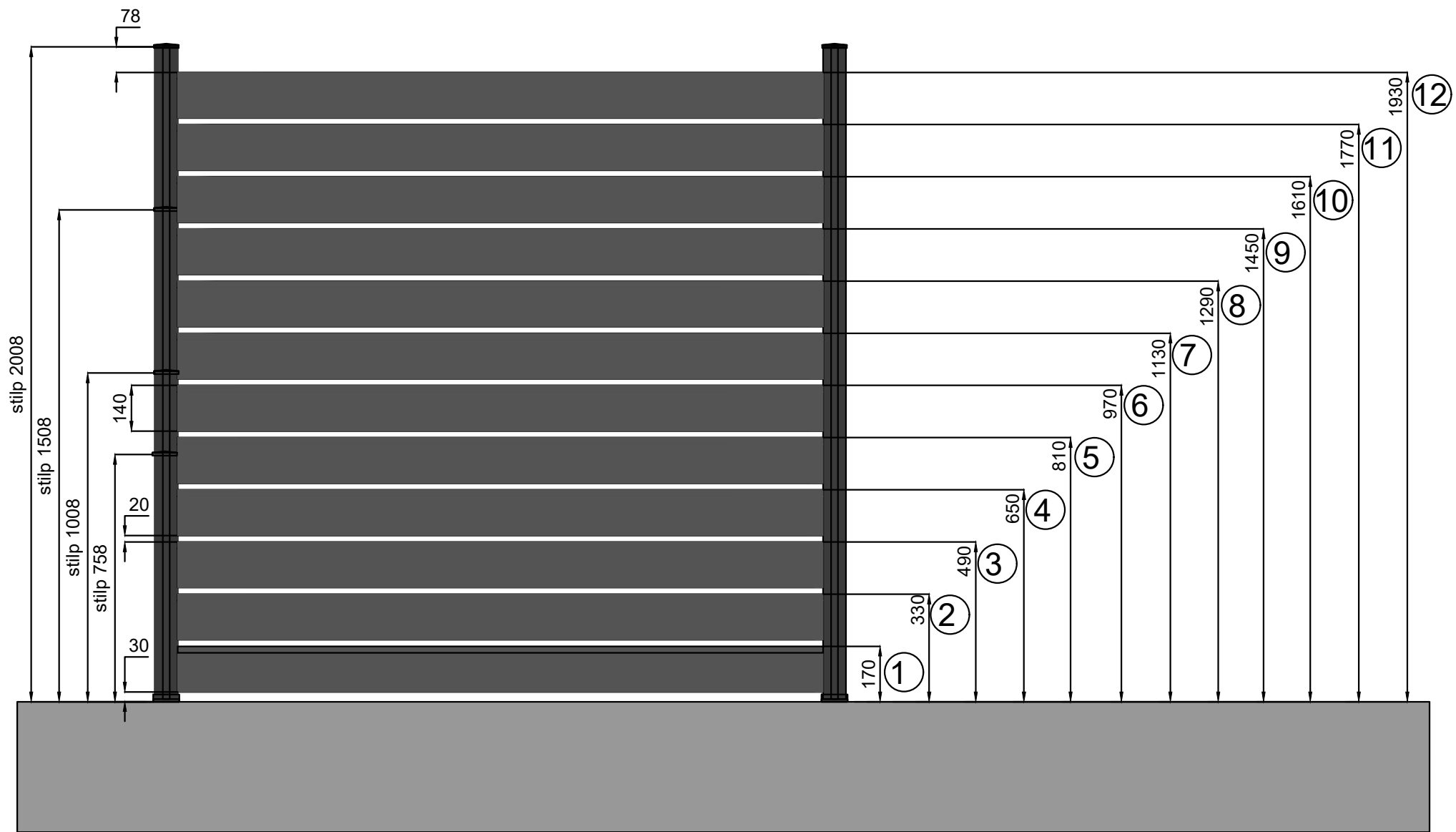

D-120/30

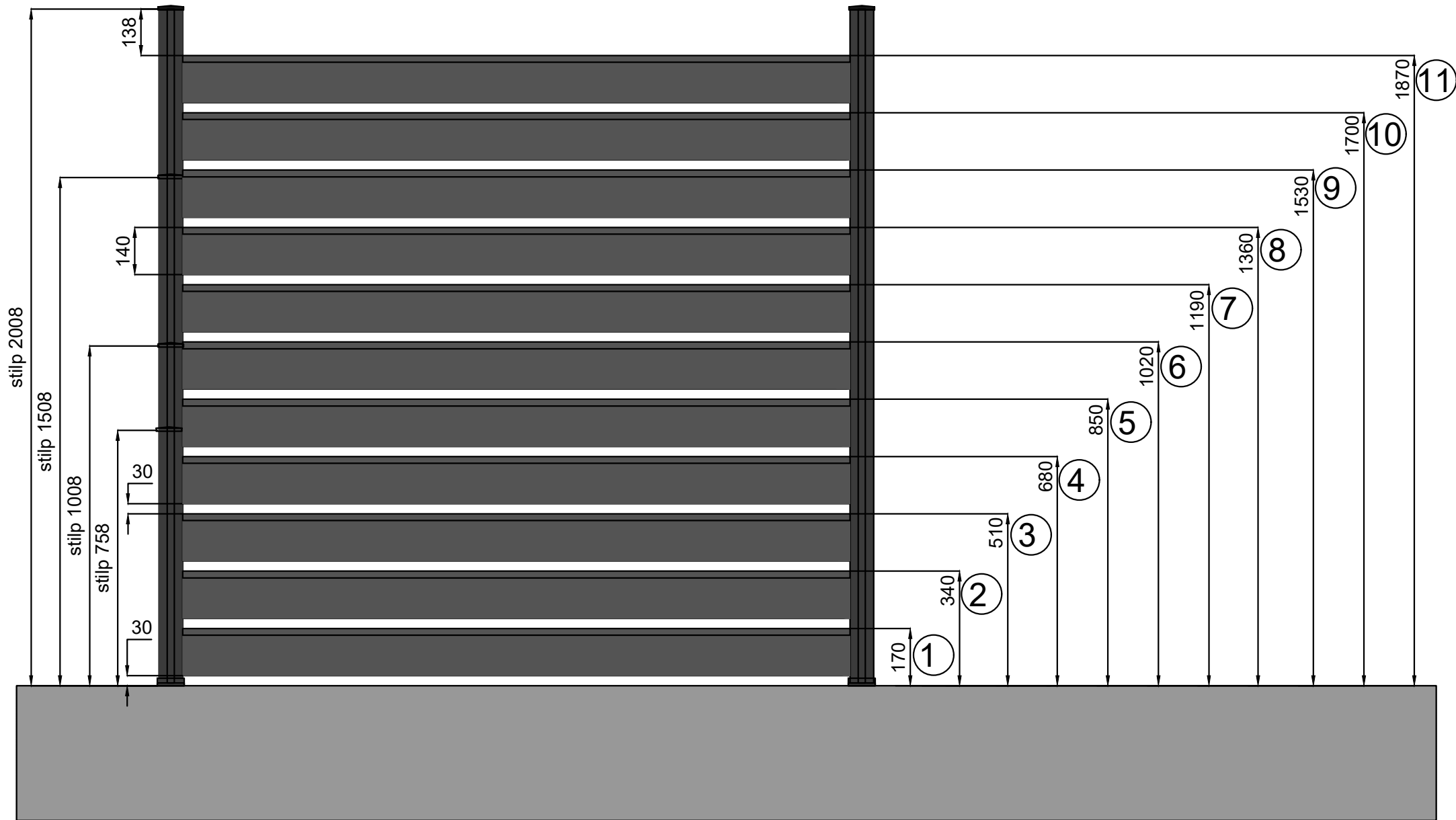

D-120/40

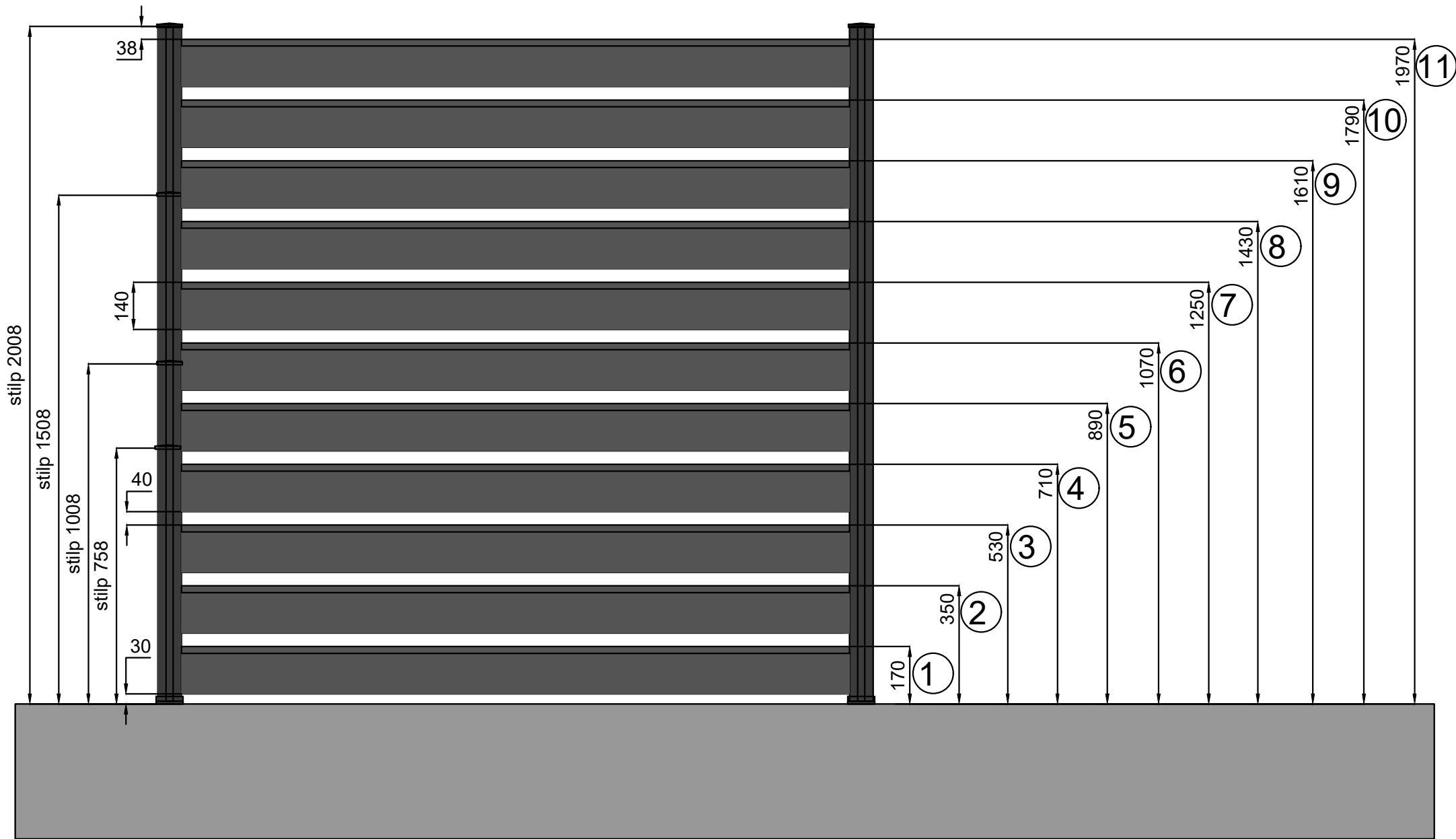

D-120/50

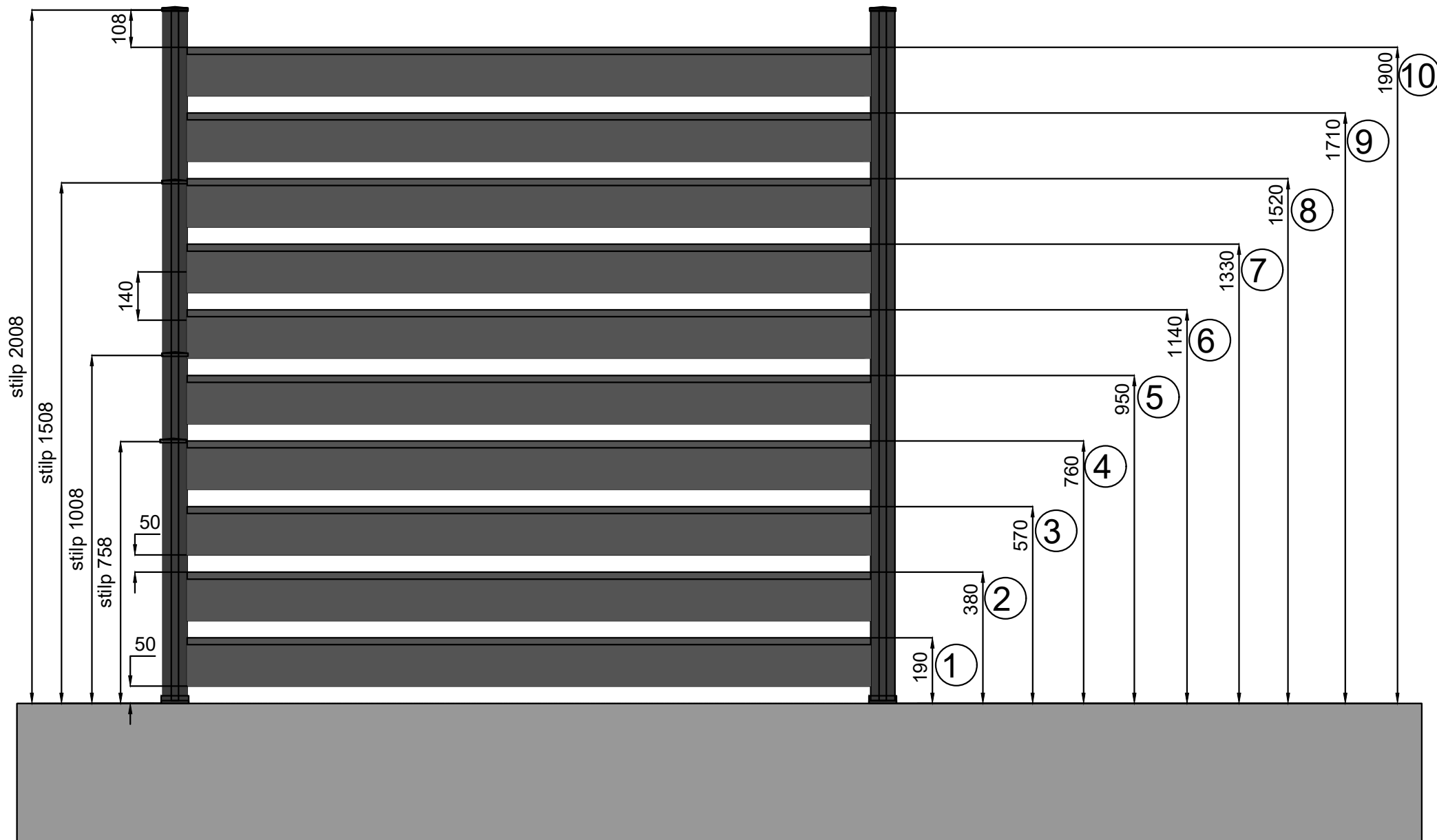

D-120/70/40

